

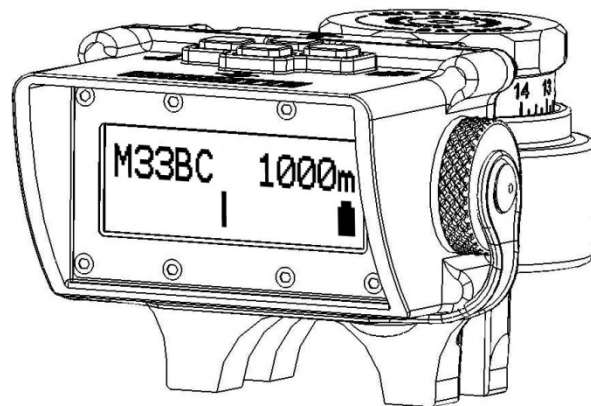

Optical Ranging System (BORS™)



Operator's Manual

11/06/08

USE OF THIS MANUAL

Before you handle the Barrett Optical Ranging System (BORS), read this manual in its entirety. It is important that you understand the principles of its operation and installation procedures. Important safety topics and equipment care are also addressed. This manual should remain with the BORS and it should be transferred to subsequent owners. Additional manuals can be ordered from Barrett Firearms Manufacturing or can be downloaded from the company web site.

SAFETY GUIDELINES

WARNING
FAILURE TO FOLLOW SAFETY GUIDELINES MAY CAUSE INJURY OR DEATH.

WARRANTY AND SERVICE

Barrett Firearms Manufacturing Inc. (BFMI), warrants that this product was manufactured free of defects in materials and workmanship. For one year from the date of purchase by the original owner, BFMI agrees to correct any defect for the original purchaser by repair or replacement with the same or comparable model.

Technical specifications are subject to change without notice.

If you need factory service, whether made under warranty or not, please contact BFMI for instructions on how to have your BORS repaired.

Barrett Firearms Manufacturing Inc.
P.O. Box 1077
Murfreesboro, TN 37133-1077
615-896-2938

www.barrettrifles.com

TABLE OF CONTENTS

Use of this manual/warranty	1
Table of contents	2
About the operator's manual	3
BORS description	4
Kit contents	4 - 5
Technical specifications	5
Installing on a riflescope	6 - 8
Installing the battery	9
Power the BORS on or off	10-11
Operator's screen	12-13
BORS keypad functions	14-15
Selecting cartridge	15
Changing Units	16
Change Setting	17-19
Cartridge information	19
Point of Impact Zeroing Procedure	20-21
Ranging with the BORS	22-23

About the Operator's Manual

The BORS manual is organized into 4 main sections:

1. BORS description.

This section explains the functions of the BORS and the contents of the kit. The section also outlines the technical specifications and memory storage capacity.

2. Installation and mounting.

This section describes how to install the BORS unit on Mil-Std 1913 rail and its host rifle telescope.

3. Battery installation and power on/off.

This section details battery installation and how to properly turn the BORS power on and off, and describes the information displayed on the "OPERATOR'S SCREEN"

4. Keypad usage and screen displays.

This section describes each button on the keypad and how to use the information on the display screens. This section also explains how to calibrate the unit, "zero" the BORS and scope with live fire, and use the BORS to determine range.

Explanation of format and terms used in this manual:

<p style="text-align: center;">WARNING A WARNING DESCRIBES AN ACTION THAT MAY RESULT IN SERIOUS INJURY OR DEATH.</p>
--

<p style="text-align: center;">Caution A caution describes an action that may result in damage to equipment.</p>
--

<p style="text-align: center;">Note A note is a recommended operating technique.</p>
--

Text describing a BORS screen display is "CAPITALIZED AND IN QUOTATIONS".

Barrett Optical Ranging System (BORS) Description

BORS is a ballistic computer that mounts directly to the rifle telescope. The BORS is coupled to the scope's elevation adjustment post. Its body serves as the rear upper scope ring cap.

The BORS continuously measures air temperature, barometric pressure, and bore line angle. Given these inputs, it automatically calculates a ballistic solution for a specific user selected cartridge. The user simply adjusts the BORS elevation knob to match the target's known range with the range displayed on the BORS. This eliminates the need for "counting clicks" as target ranges change, allowing the shooter to focus on other environmental conditions, and quickly engage multiple targets at varying ranges.

The BORS memory is sufficient to hold 100 cartridge tables. Installation can be completed in about the same time as it takes to mount a rifle telescope.

Kit Contents

The BORS kit, figure 2-1, includes the following:

- One Barrett Optical Ranging System with factory installed cartridge tables

- One Barrett Ballistic Software CD with Quickstart Guide

- One USB to BORS Interface Cable

- Optional set of Barrett Zero-Gap™ 30mm Scope Rings

- One lithium ion CR-123 battery

- One BORS operator's manual

- One BORS knob adapter with 3 set screws

- One BORS elevation knob with set screw

- One Tool Kit containing the following:

 - Four 8-32 x 1 1/2" T-25 Torx® socket head cap screws

 - One 10-24 x 1/2" flat head cap screw

 - One 3/32 L-shaped Allen Wrench

 - One T-25 L-shaped Torx® Wrench

 - One tube Loctite® 222 low strength adhesive

 - Four extra 10-24 x 1/4" set screws

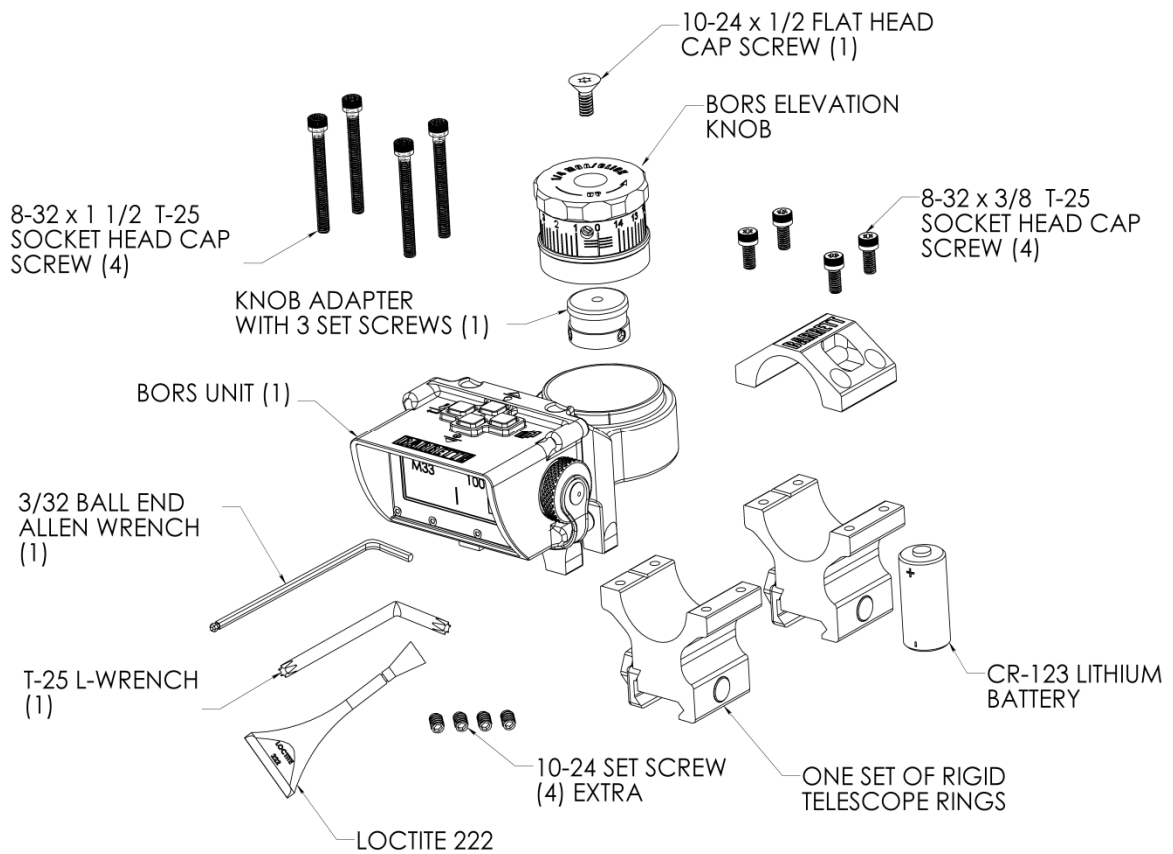

Figure 1-1

BORS Technical Specifications

Weight:	13 oz. (370 grams)
Display:	12 x 2 Character LCD
User Interface:	4 Button Keypad
Operating Temperature Range:	-4°F to 158°F (-20°C to 70°C)
Temperature Response Time:	1 minute per 1°F of change
Altitude Range:	-1,000ft to 20,000ft (-300m to 6,000m)
Barometric Pressure Resolution:	1inHg or 1kPa
Angular Range:	±90°
Angular Resolution:	2°
Battery Type:	CR-123
Battery Life:	30 hours minimum at 1,500mA/hr battery rating

Installing the BORS on a rifle telescope

WARNING
MAKE CERTAIN THE FIREARM IS UNLOADED. REFER TO YOUR FIREARM'S OWNER'S MANUAL TO ENSURE THE FIREARM IS SAFE.

Note
Ensure that the ring clamp tightening nuts are on the left side. Orient the ring clamp so that the "step cut" side of the clamp bears on the ring and the "angle cut" of the clamp bears on the mounting rail. Do not attempt to remove the nut from the bolt. Figure 2-1.

1. Remove one of the scope ring caps and place the scope rings on the 1913 mounting rail eight slots apart with just the ring base towards the rear. From side view, four complete mounting ridges will be visible. Hand-tighten the clamp nuts on both rings ensuring a stable work platform (proper eye relief may be achieved later by moving the entire assembly). Figure 2-2.

Note
Some scope models may require different spacing between rings.

2. Use the front Scope Ring to hold the riflescope in the rings. Remove the front scope ring cap using the T-25 Torx wrench. Place the riflescope in lower rings, and start the threads of the cap screws (4) into the front lower ring. Tighten the indexed side only. The scope should still be able to move in the scope rings, loosen slightly if required. Figure 2-3

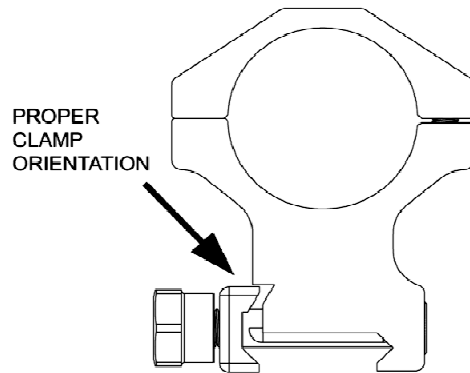

Figure 2-1

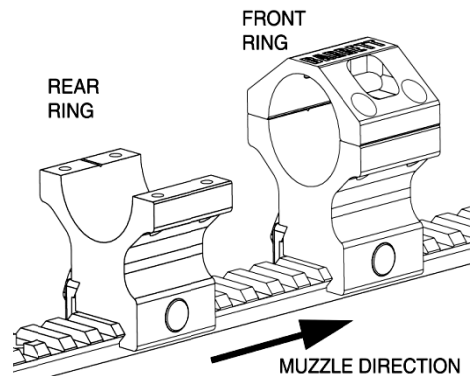

Figure 2-2

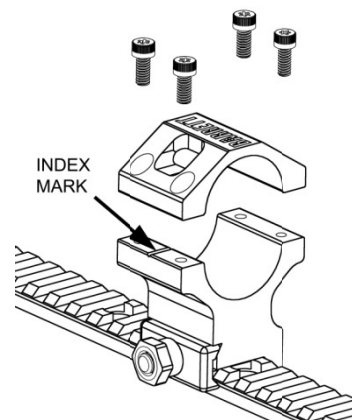

Figure 2-3

3. Adjust the elevation knob to the highest setting, then remove the Leupold elevation knob (3/32in. Allen wrench) to expose the elevation adjustment post. Figure 2-4.

Caution
Do not attempt to rotate the riflescope's elevation knob past its designed mechanical limit.

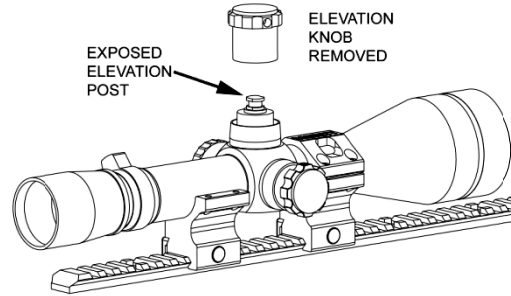

Figure 2-4

4. Place the knob adapter over the elevation post. Apply slight downward pressure to ensure that all set screws (3/32in Allen) are seated below the outside diameter of the knob adapter and tighten evenly. Use Loctite® if desired. Figure 2-5.

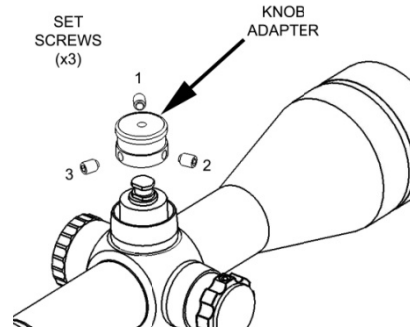

Figure 2-5

5. Place the BORS unit on top of the rear scope ring. Start the four BORS mount screws (T-25 Torx® wrench), but do not tighten them. Figure 2-6.

6. Place the BORS elevation knob over the knob adapter. Ensure the knob is fully seated on the adapter then secure with knob screw and tighten the Knob set screw (3/32in Allen). Figure 2-7.

Caution
Do not over-tighten the set screw.

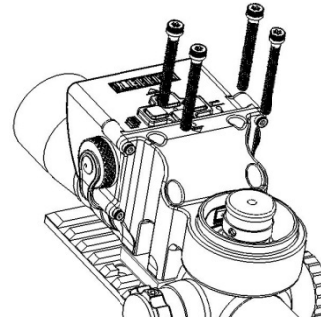

Figure 2-6

7. Rotate the BORS elevation knob to the lowest elevation setting, then back up one complete revolution. The o-ring on the elevation knob serves to align the BORS housing with the scope and reticle.

Caution
Do not attempt to rotate the riflescope's elevation knob past its designed mechanical limit.

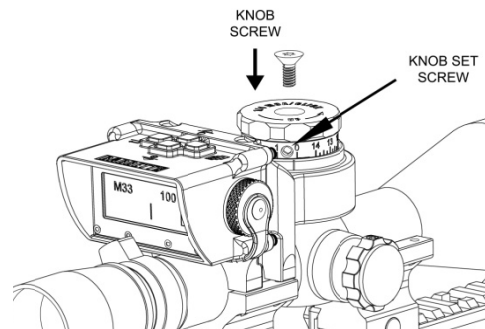

Figure 2-7

8. Ensuring the elevation knob rotates freely, evenly tighten Mount Screws (T-25 Torx®) # 1 and # 2. Figure 2-8. There should be a gap between BORS and the scope ring bases. Figure 2-9.

Note
Rotating the elevation knob back and forth about one half revolution in each direction through the tightening process will improve the BORS knob alignment.

9. Tighten mount screws # 3 and # 4, and torque all four mount screws, in sequence # 1 to # 4, to 35in/lbs or 3.95Nm. Figure 2-8.

10. Verify the elevation knob does not bind through entire range of movement, all the way up to the highest setting, then back down to the lowest. If binding occurs, loosen mount screws and repeat Steps "7" through "9".

Caution
Do not attempt to turn the scope's elevation knob past its designed mechanical limit.

11. Torque the front cap screws, indexed side first, to 35in/lbs or 3.95Nm. Use Loctite® if desired.

12. To adjust for eye relief, loosen the clamp nuts and move the BORS and scope as a unit along the rail to the desired eye relief distance. Tighten the clamp nuts to 65in/lbs or 7.34Nm. Use Loctite® if desired.

Caution
Over-torquing the clamp nuts may damage the rail mount or scope ring bases.

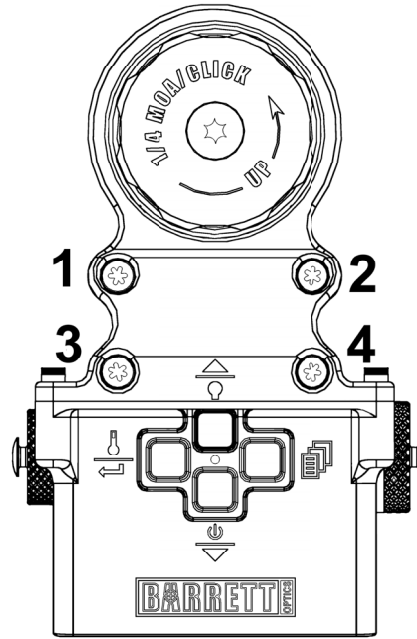

Figure 2-8

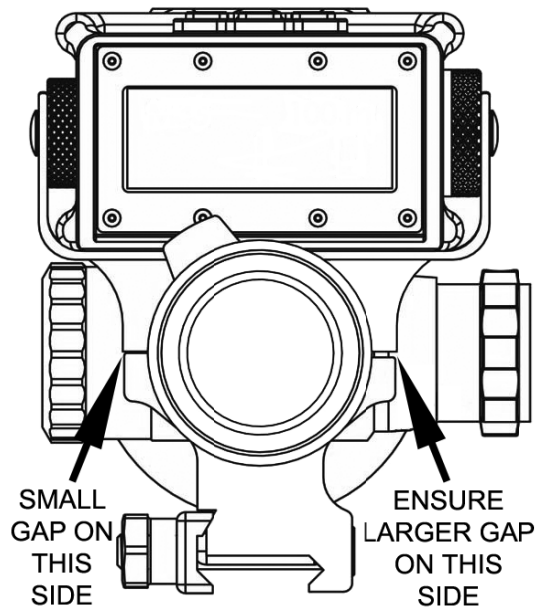

Figure 2-9

Installing the battery

One CR-123 lithium cell (3.2 Volts) battery is included with the BORS kit. This battery is commonly used for cameras and high-intensity flashlights.

Note

CR-123 Lithium batteries with a 1,400mA/hr (milliamp/hour) rating or higher are recommended for maximum battery life.

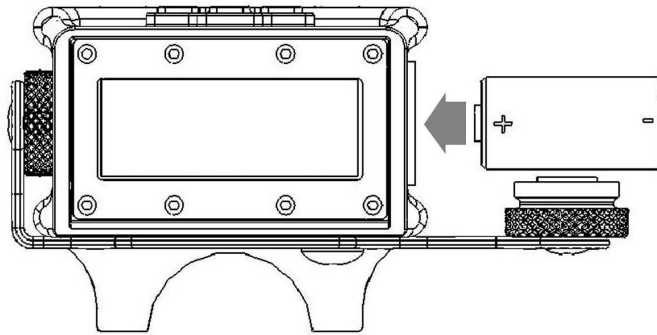

Figure 3-1

1. Rotate the battery cap counter-clockwise to remove the cap from the BORS.
2. Tilt the BORS to the right side to remove any battery in the case.
3. Insert the battery into the case, positive end first.
4. Reattach the battery cap by rotating the cap clockwise into case threads.

Caution

Ensure battery cap threads are seated properly to avoid “crossthreading” the aluminum housing.

Caution

Installing the battery backwards into the case is not a recommended method for battery storage.

Powering the BORS on or off

Caution

BORS is designed to be powered on when elevation adjustments are made. Moving the elevation dial when BORS is off will result in lost data and recalibrating the BORS to your scope will be required (see page 21).

To power on the BORS , press and hold the  button, see Figure 3-2, for one or two seconds. The backlight will turn on and then the first initialization screen will be displayed.

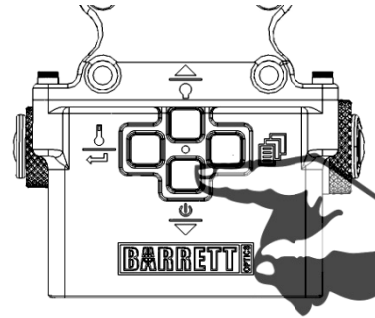

Figure 3-2

Note

A battery with a low charge remaining may not provide sufficient power to the BORS causing only the backlight to turn on and no text or a shaded top row of the display to appear. Replace battery with a new or known good one, and retry.

To power off the BORS , press and hold the  button for 5 seconds or until “SHUTTING DOWN” is displayed.

Figure 3-3

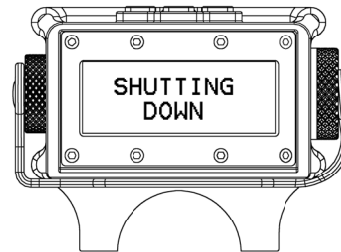

Figure 3-3

Note

Turn the BORS power off before removing the battery to prevent the loss of selected settings.

As the BORS powers up and initializes, three different screens will be displayed. These “Initialization Screens” will only be displayed for one to two seconds and will show current installed information about the BORS. The full initialization period is about 5 seconds.

On the first “Initialization Screen”, the backlight turns on, then “BARRETT OPTICS” is displayed. Figure 3-4.

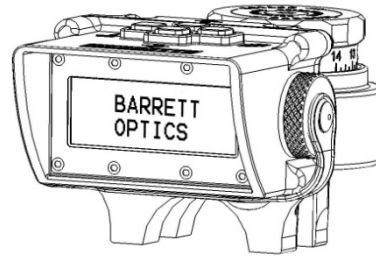

Figure 3-4

The second “Initialization Screen” is the “LIBRARY SCREEN”. This displays the current Cartridge Library programmed in the BORS. Figure 3-5

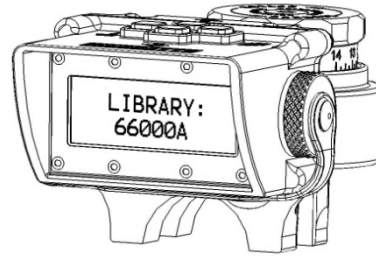

Figure 3-5

The third and final “Initialization Screen” is the “VERSION SCREEN”. This displays the BORS firmware version currently installed. Figure 3-6.

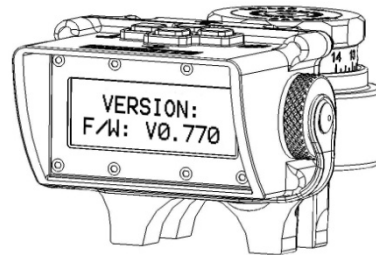

Figure 3-6

Note

Actual “LIBRARY SCREEN” and “VERSION SCREEN” may differ due to manufacturer updates to installed cartridge library or firmware.

Note

Elevation adjustments can be made during the initialization period although changes will not be displayed until initialization is complete and BORS displays the “OPERATOR’S SCREEN”.

The “OPERATOR’S SCREEN”

The screen displayed immediately following BORS initialization is the "OPERATOR'S SCREEN". This is the default BORS screen. Figure 3-7.

The current selected cartridge is displayed in the upper left corner.

In the upper right corner is the range where the horizontal line of the reticle and the calculated cartridge trajectory coincide for bullet impact. The unit of measure can be set to yards, "y", or meters, "m". See Page 20 for changing the units of measurement basis.

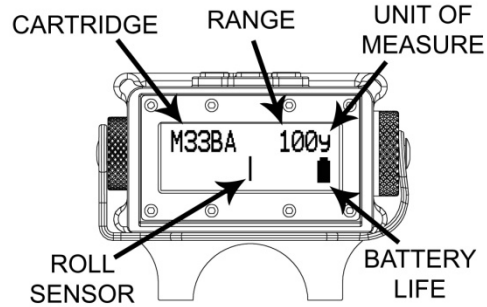

Figure 3-7

Note

The range displayed on the “OPERATOR’S SCREEN” is only valid if the cartridge fired is the selected cartridge in BORS.

Note

The default units of measurement basis are factory set to U.S.

The Battery Life Indicator is displayed in the lower right corner. A solid battery symbol is shown with over 50% battery life. A half-full battery symbol represents less than 50% battery life remaining. An empty battery symbol flashes when it is time to replace the battery. When battery charge is too low to sustain proper operation, BORS automatically saves all data then turns itself off.

In the lower portion of the "OPERATOR'S SCREEN" is the Roll Sensor Indicator which measures the side to side angle from level. An "I" will be displayed when the firearm is level. A "█" will be displayed in the direction the firearm needs to be pivoted to return to level.

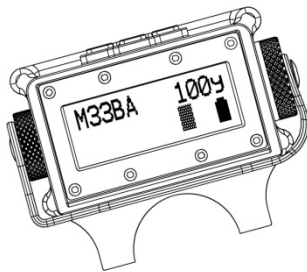

Figure 3-8
Firearm is rolled left.

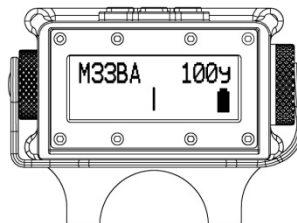

Figure 3-9
Firearm is level.

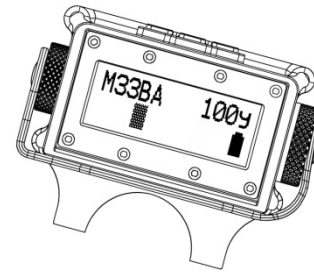

Figure 3-10
Firearm is rolled right.

The pitch sensor built into BORS measures the angle of the firearm's bore line, incline or decline, and automatically compensates the ballistic solution in the range displayed. This can be observed by the range changing while tilting the BORS forward and backward.

NOTE

If there are no changes to the Roll Sensor Indicator or range when tilting the BORS forward to back, or side to side, contact Barrett for assistance.

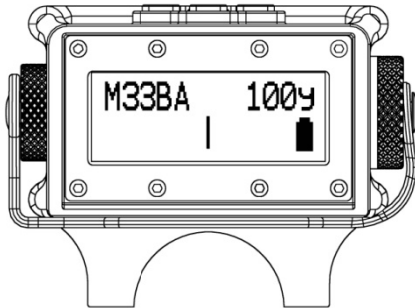

Figure 3-11

Figure 3-11 shows a BORS using a M33BA cartridge ballistic data with a calculated firing solution that provides bullet impact at 100 yards coincident with the horizontal reticle. The rifle is level and the battery has a full charge.

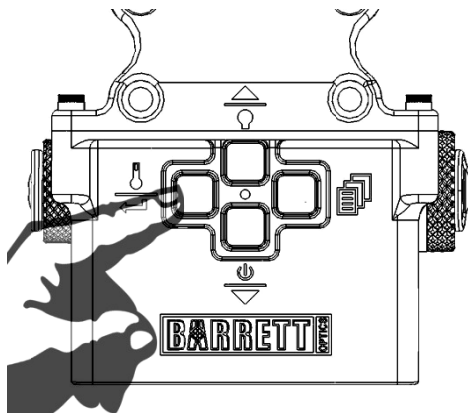







Figure 3-12

To display the current temperature, "T", and barometric pressure, "P", press the  button illustrated in Figure 12. This screen will be displayed for approximately 4 seconds before returning to the "OPERATOR'S SCREEN".





BORS Keypad Functions





The four button keypad is used to access BORS information and displays. Their function depends on whether the cartridge identification screen is displayed when the button is depressed or another screen is displayed when the button is depressed.





The following commands are active if the “OPERATOR’S SCREEN” is displayed when a keypad button is depressed:

1.  Power on/off.
2.  Display temperature and barometric pressure.
3.  Power on the LCD backlight.
4.  Select display screen menus.

The following commands are active if any screen other than the “OPERATOR’S SCREEN” is displayed when the keypad button is depressed:

1.  Scroll menu down.
2.  Select menu item.
3.  Scroll menu up.
4.  Select display screen menus.

Title	Icon	Function
<u>Menu</u>		Used to access BORS display menus.
<u>Temperature/Select</u>		Displays temperature, barometric pressure, and select menu item.
<u>Light/Scroll Up</u>		Illuminates the display and scrolls the menu up.
<u>Power/Scroll Down</u>		Powers the BORS on, off, and scrolls the menu down.

Press the  button as illustrated in Figure 4-1. This will allow access to one of six display screens. The screens are accessed by either scrolling up , or scrolling down . The screens are arranged in the following order: “ZERO CARTRIDGE”, “DETERMINE RANGE”, SELECT CARTRIDGE”, “CARTRIDGE INFORMATON”, “CHANGE UNITS”, and “CHANGE SETTINGS”. To select one of the screens, press the  button, or, press the  button to return to the previous screen.

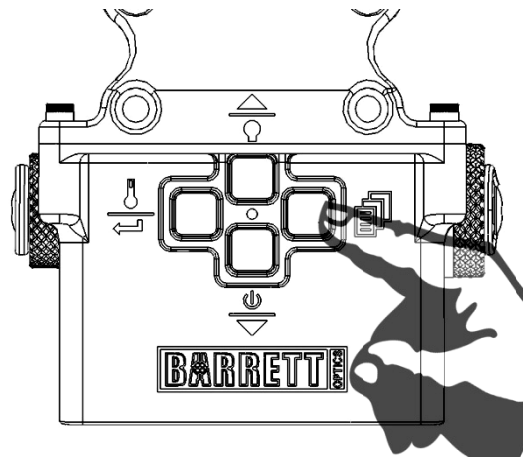





Figure 4-1

SELECT CARTRIDGE

1. Press and release the  button.
2. Press and release the  button until the display reads “SELECT CARTRIDGE”.

3. Press and release the  button to select the menu item. The currently selected cartridge will be displayed in the top row with the cartridge description in the bottom row. Depending on the description length, the words may scroll across the bottom of the screen. Figure 4-2

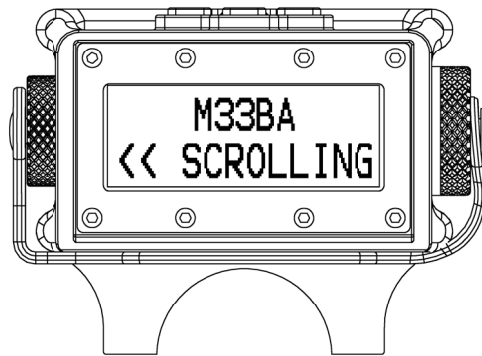









Figure 4-2

4. Using the scroll buttons ( or ), scroll to the desired cartridge.
5. Press and release the  button when the desired cartridge is displayed. BORS will return to the “OPERATOR”S SCREEN” with the new selected cartridge shown.

CHANGE UNITS

Changing Units of Measurement Basis

BORS displays units of measurement on all screens based on either metric or U.S. equivalents. To change from the currently displayed basis to the other basis:

1. Press the  button.
2. Press the  or  button until the display reads “CHANGE UNITS”.
3. Press the  button to change the basis from the current to the other basis.

Note

The user can confirm changing measurement basis by viewing the range units displayed on the “OPERATOR’S SCREEN” as either “y” or “m”.

Displayed Metric and U.S. Equivalents

Units	Range	Temperature	Barometric Pressure	Muzzle Velocity	Bullet Caliber	Bullet Mass	Target Size
US	Yards	Fahrenheit	Inches of Mercury	Feet per second	Inches	Grain	Inches or Feet
Metric	Meters	Celsius	Kilopascals	Meters per Second	Millimeters	Grams	Meters

Figure 4-3

CHANGE SETTINGS

Calibrating BORS to the rifle telescope









There are three times when calibrating BORS to the scope will be required:

1. After initial mounting of BORS to the scope.
2. If the elevation dial is adjusted while BORS is powered off and settings are lost.
3. Loss of power to BORS when in use. This **does not** include automatic BORS Power Off for a low battery.

Caution

Do not attempt to turn the rifle scope's elevation knob past its designed mechanical limit during calibration.

Calibration procedure:

1. Rotate the BORS elevation knob clockwise until it reaches its lowest point.
2. Press the  button to enter the menu screen.
3. Press the  button until the screen displays "CHANGE SETTINGS".
4. Press the  button. The screen will display "ADJUST BACKLIGHT".
5. Press the  button once. The screen will display "DEVICE SETUP".
6. Press the  button to select this screen.
7. Press the  button to display "ZERO ELEVATION".
8. Press the  button to select this screen. BORS will prompt to "CONFIRM" or "CANCEL" the calibration as shown in Figure 4-4.
9. Press the  button to "CONFIRM", or the  button to "CANCEL" the calibration. "DEVICE SETUP" will be displayed.

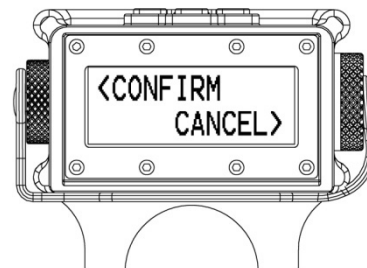









Figure 4-4

Note







The calibration will not be properly completed if "CANCEL" is selected.

10. Press the  button until the "OPERATOR'S SCREEN" is displayed. Calibration is completed.

Adjusting the Backlight

1. Press the  button to enter the menu screen.
2. Press the  button until the screen displays “CHANGE SETTINGS”. Press the  button to select this screen.
3. The screen displays “ADJUST BACKLIGHT”. Press the  button to select this screen.
4. The screen displays “BACKLIGHT SCROLL UP/DN”. See Figure 4-5.
5. Press the  or the  button to adjust the display brightness.
6. Press the  button to exit the menu system.

Checking the version of BORS

1. Press the  button to enter the menu screen.
2. Press the  button until the screen displays “CHANGE SETTINGS”.
3. Press the  button. The screen will display “ADJUST BACKLIGHT”.
4. Press the  button twice to display “VERSION INFORMATION”.
5. Press the  button to display currently loaded hardware and firmware versions.
6. Press the  button to exit the menu system.

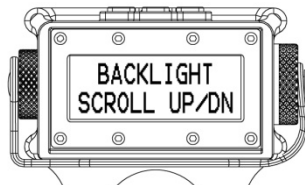

Figure 4-5

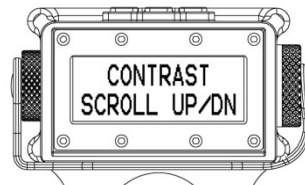



















Figure 4-6







Adjusting the Contrast

1. Press the  button to enter the menu screen.
2. Press the  button until the screen displays “CHANGE SETTINGS”.
3. Press the  button. The screen will display “ADJUST BACKLIGHT”.
4. Press the  button. The screen will display “ADJUST CONTRAST”.
5. Press the  button to select this screen. The screen displays “CONTRAST SCROLL UP/DN”. See Figure 4-6.
6. Press the  or the  button to adjust the display contrast.
7. Press the  button to exit the menu system.

Adjusting the Backlight Timer (length of time the backlight will illuminate)

1. Press the  button to enter the menu screen.
2. Press the  button until the screen displays “CHANGE SETTINGS”.
3. Press the  button. The screen will display “ADJUST BACKLIGHT”.
4. Press the  button. This will display “DEVICE SETUP”.
5. Select this display by pressing the  button. “ZERO ELEVATION” will be displayed.
6. Now press the  button to display “BACKLIGHT TIMER”.
7. Press the  button to select this screen.
8. Use the  or the  button to adjust the time the backlight remains illuminated.

CARTRIDGE INFORMATION



1. Press and release the  button to enter the menu screen.
2. Press the  or the  button until the screen displays “CARTRIDGE INFORMATION”.
3. Press and release the  button. “DESCRIPTION:” is shown on the top line of the display. Below “DESCRIPTION:” will be displayed a user-defined summary of the cartridge. Depending on the length of the description, the words may scroll across the screen.
4. Pressing the  or the  button will display the “CALIBER”, “BULLET MASS”, “BULLET B.C.”, or “MUZZLE VELOCITY” of the cartridge selected.

ZERO CARTRIDGE

Point of impact zeroing procedure for the BORS at the live fire range

The zeroing procedure for the BORS is similar to zeroing any common rifle telescope. The default distance for zeroing the cartridge point of impact is 100 yards or 91 meters. The following steps zero the BORS with a specific cartridge, rifle, and rifle telescope.

BORS Cartridge ZERO Procedure:

1. Select the desired cartridge on the BORS “SELECT CARTRIDGE” screen and fire a series of shots to obtain a representative group of point of impact with that cartridge type.
2. Adjust the BORS elevation knob until the projectile’s point of impact coincides with the rifle telescope’s horizontal reticle. If desired, adjust the rifle scope’s left/right knob until the projectile’s point of impact coincides with the rifle telescope’s vertical reticle. The BORS has no influence on windage adjustments.
3. ZERO the cartridge selected in BORS by doing the following:
 - a. Press the  button once. “ZERO CARTRIDGE” will be displayed.
 - b. Press the  button to select this screen. BORS will prompt “CONFIRM”, or , “CANCEL”.
 - c. Press the  button to “CONFIRM” the selection. BORS will return to the “OPERATOR’S SCREEN” with the Range of “100y” or “91m” depending on the measurement basis.

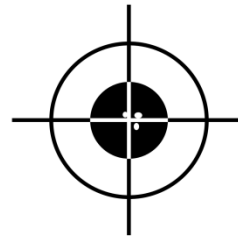



Figure 4-7

Note

“100y” or “91m” is the factory default range displayed after zeroing the cartridge. The Range displayed may differ if the BORS was programmed with a customized Cartridge Library with a user defined Sight Zero Range in the Barrett Ballistic Software.

4. Power the BORS off by pressing and holding the  button until “SHUTTING DOWN” is displayed. BORS will power off. The battery may be removed to prevent accidental power on of the BORS.

Note

These next steps are for setting the Zero reference of the elevation knob by aligning the “0” mark on the knob with the preferred index marking on either the right or left side of the BORS housing. This is only recommended for the primary, or most frequently used cartridge.

Note

This is the only time the elevation knob should be moved while the BORS unit is off where recalibrating the BORS to the scope is not required.

5. Align the “0” mark on the elevation knob to the preferred Zero reference index marking by doing the following:

- a. Loosen the set screw and flat head screw on the BORS elevation knob until the knob rotates freely on the adapter without moving the actual adjustment post (no clicks). Figure 4-8.
- b. Align the “0” mark on the knob to the preferred side index marking.
- c. Hold the knob in place and carefully tighten the flat head screw first, and then the set screw.

1. Loosen the flat head T-25 Torx® screw.

2. Loosen the set screw.

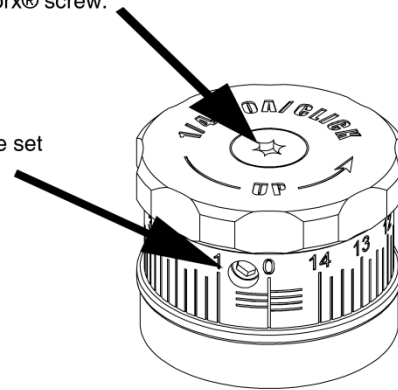

Figure 4-8

6. Reinstall the battery if removed and power the BORS unit on. Ensure the correct cartridge is selected and fire another series of shots to confirm the BORS and scope are “Zeroed” to the firearm.
7. Repeat steps 2 through 6 if proper “Zero” was not achieved with the BORS or the scope.

Determining the Range to the Target with the BORS





BORS provides the user with the ability to measure and then display the range to a reference object or target. This distance can be expressed in either yards or meters. The known vertical dimension of the reference object is used to calculate the distance to that object.

Note

Range measurements will be most accurate when the rifle is held steady and a large reference object is selected.

Figure 3-17 shows the reference object as a vehicle known to be approximately 6 feet tall. The user selects “6 FEET” as the height of the reference object. Using the BORS elevation knob to measure the amount elevation adjustment required to move the horizontal reticle line the height of the vehicle, BORS is able to calculate the distance to that vehicle.

Range Finding Procedure

1. Press the  button to enter the menu screen.
2. Press the  button until the screen displays “DETERMINE RANGE”.
3. Press the  button to select this screen.
4. The screen will display “TARGET SIZE?” on the top line. The bottom line will display either “1 FOOT” or “1 METER” depending on selected measurement basis.
5. By pressing the  or the  button, the user can scroll to display the approximate vertical size of a reference object. If U.S. equivalents have been selected, “1 FOOT”, “3 FEET”, “6 FEET”, “9 FEET”, “12 FEET”, “15 FEET”, and “20 FEET” will be displayed. If metric units have been selected, “.5 meter”, “1 METER”, “2 METERS”, “3 METERS”, “4 METERS”, “5 METERS”, and “6 METERS” will be displayed.

1. From a steady rest, position the horizontal crosshairs at the top or bottom of the reference object. Press the  button to select the height of the reference object. “MEASURE TRGT USING ELEV” will be displayed.

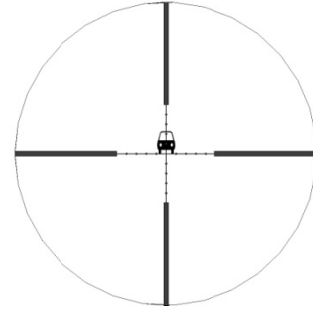

Figure 3-17

2. Using the BORS elevation knob, move the horizontal crosshair either from the top of the reference object to its bottom, or from the bottom of the object to its top as illustrated in Figure 3-18.

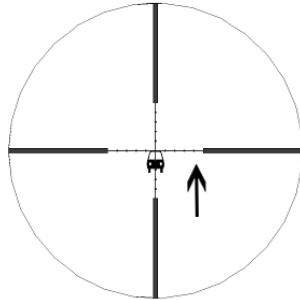

Figure 3-18

NOTE

The measurement will be most accurate when the rifle is kept steady throughout the procedure.



3. Press the  button to display the range to the reference object. The distance to the reference object will be displayed as “TARGET RANGE 1012 YARDS” as illustrated in Figure 3-19.



Figure 3-19

4. Press the  button to return to the “OPERATOR’S SCREEN”. Use the BORS elevation knob to dial the reference object’s range. Your riflescope elevation crosshairs are now adjusted so that your point of aim is the point of impact at the reference object’s calculated range.

